



**49" 3840 x 1080 144Hz E-LED
Curved Gaming Monitor**

INSTRUCTION MANUAL



DGVIEW490

Precaution

Before using this product, please read this User Manual carefully and keep it well

- Keep the monitor away from water sources or damp places, such as bath rooms, kitchens, basements and swimming pools.
- Make sure the monitor is placed on a flat surface. If the monitor falls down, it may cause human injury or device damage.
- Store and use the monitor in a cool, dry and well ventilated place, and keep it away from emission and heat sources.
- Do not cover or block the vent hole in the rear casing, and do not use the product on a bed, sofa, blanket or similar objects.
- The range of the supply voltage of the monitor is printed on the label on the rear casing. If it is impossible to determine the supply voltage, please consult the distributor or local power company.
- If the monitor will not be used for a long period, please cut off the power supply to avoid electric shock in rainy days and damage due to abnormal supply voltage.
- Please use a reliable grounded socket, Do not overload the socket, or it may cause fire or electric shock.
- Do not put foreign matters into the monitor, or it may cause short circuits resulting fire or electric shock.
- Do not disassemble or repair this product by self to avoid electric shock. If faults occur, please contact the after-sales service directly.
- Do not pull or twist the power cable forcedly.
- There is a polarizer layer (not a protective film) on the surface of the screen. Do not peel it off, or the product may be damaged and the warranty will be invalid.

Package Content

Packing list

- Please check that the package of the monitor contains all parts. If any part is lost, please contact the distributor.
- The color and shape of parts may vary with models. Figures in this User Manual are for reference only.
- Cables supplied may vary with purchased products. Figures in this User Manual are for reference only.



Monitor

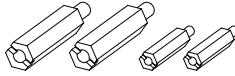

Mount hexagon irons

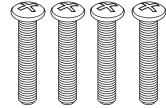

Screws

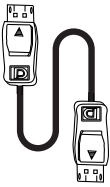

DP cable

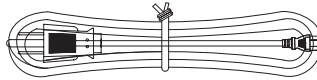

Power cable



Stand

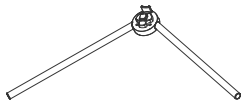

Base



Remote Control



User Manual

Installation

Installation of base

1. Open the package, take out the product with foam still attached, and gently place it on a desktop or table.

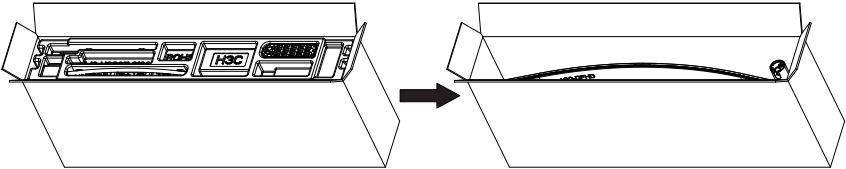

2. Lock the base and stem with three screws.

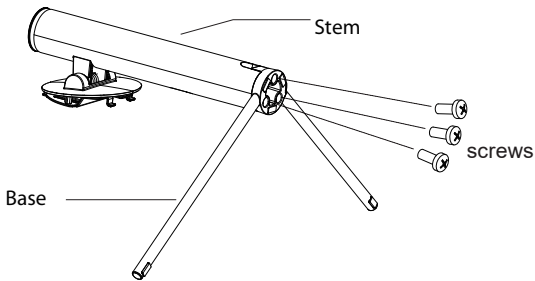

3. Take out the monitor and remove the bottom foam section.

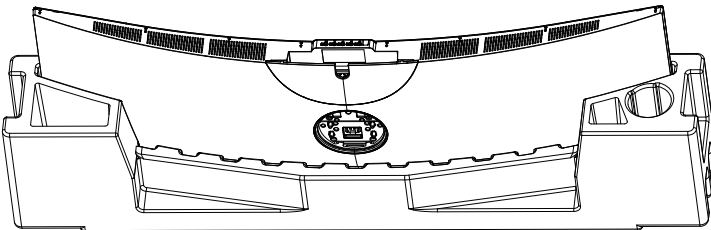

4. Align the stand stem's bracket with the opening on the back of the monitor, and carefully insert bracket. The pieces should click into place.

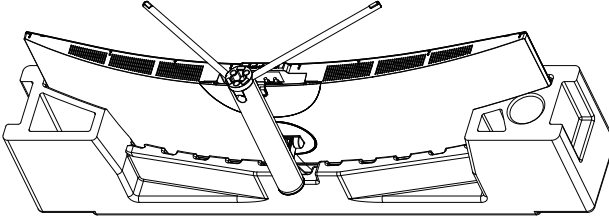

5. When remove the base, take off the decorative cover of the back shell and pull down the quick remove button to remove the base.

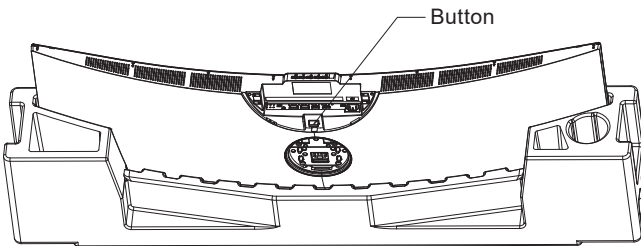

6. Simply hold the stand with hand to stand the monitor upright.

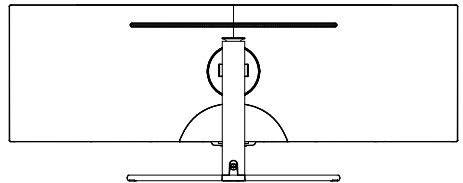

-  Note: During standing of the monitor, do not take out the monitor from foams, and do not pinch the liquid crystal screen with hand to avoid damage to the screen.

Installation of mount

1. Open the package, take out the product with foam still attached, and gently place it on a desktop or table.

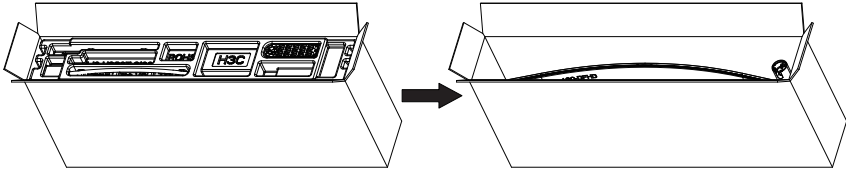

2. Remove the original screws (1) from the opening in the back of the monitor. Follow the directions received with your mount, stand, or accessory and install the monitor on the wall or fixture as desired. Remember to use the included screws when attaching anything to the back of the monitor. Refer to the image (2) for correct screw placement.

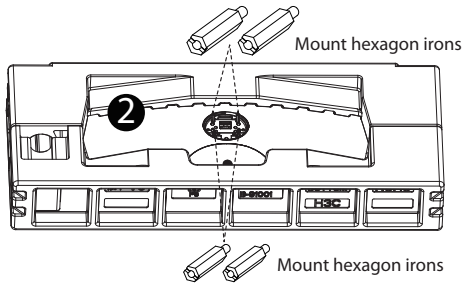
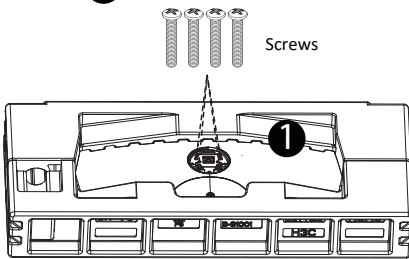

5. During padlocking of the monitor, do not pinch the screen with the hands to avoid damaging the screen. Install the mount to the mount stud by referring to the user manual of the mount (purchased separately). Tips: The mounting hole distance of the mount for the product is 75x75mm.

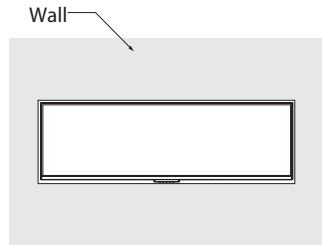
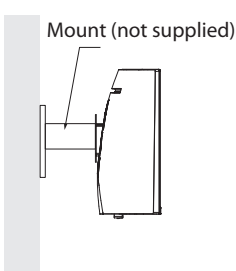

- ⚠ Notes:** To prevent the monitor on the mount from failing, please install it firmly and protect it fully. Do not place or hang any object on the mount, and the using height of the mount should be less than 2 meters.

Adjustment of monitor

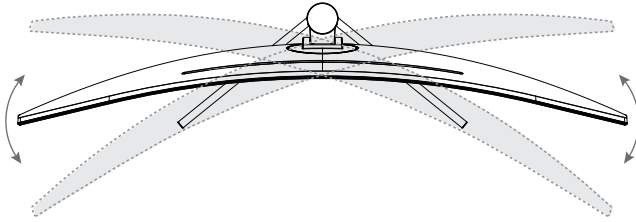

Rotation angle
 $-15^{\circ}(\pm 2.0^{\circ})$ - $+15^{\circ}(\pm 2.0^{\circ})$

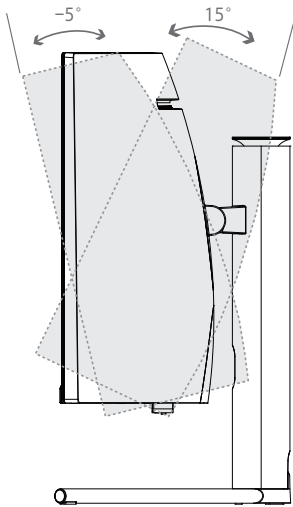

Tilting angle
 $-5.0^{\circ}(\pm 2.0^{\circ})$ - $+15^{\circ}(\pm 2.0^{\circ})$

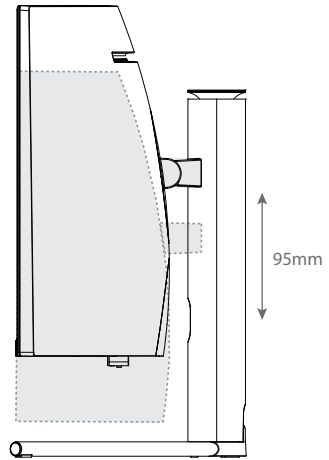

Height adjustment
0- 95mm (± 5.0 mm)

Instructions for use

Description of buttons

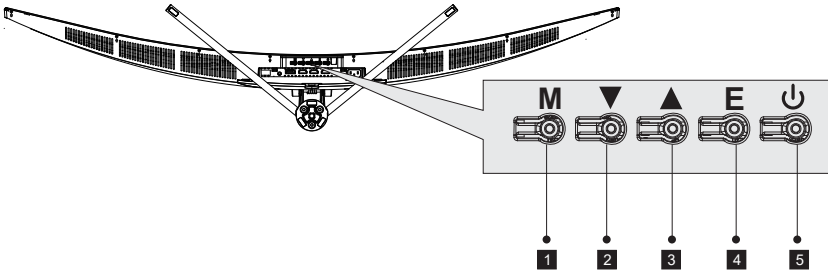

Button	Function
1	Menu selection key: Enter the next menu / shortcut to the main menu
2	Downward selection key: Move down in the menu/quickly enter the game sight
3	Up selection key: Move up in the menu / quickly enter the light console
4	Exit/Hotkey: Return to the previous menu / Quick access to switch color format
5	Power switch key: Press to turn on/off the monitor

Explanation of indicator light

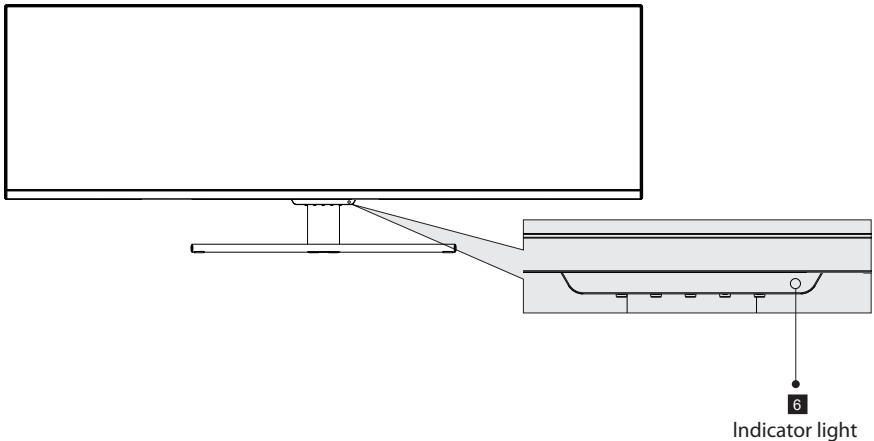

6. Indicator light: blue light indicates the power is on and the monitor runs normally. Flashing blue light indicates no video signal detected or low voltage. Please make sure that your computer is turned on and all video cables are fully plugged in and/or connected.

Remote Control

	Press to turn the monitor on or off.
	Press to switch between HDMI or DP input.
OK	Press to enter the OSD menu or press to
	After entering the OSD settings menu, press any of the arrow buttons to move within the menu. After entering the navigation menu, press to enter the LED effects console. Press directly to switch ECO modes.
	Press to turn HDR on or off.
	Press to exit the OSD menu or return to the previous menu.
	Press to turn Gameplus mode on or off.
	Press to increase volume.
	Press to decrease volume.

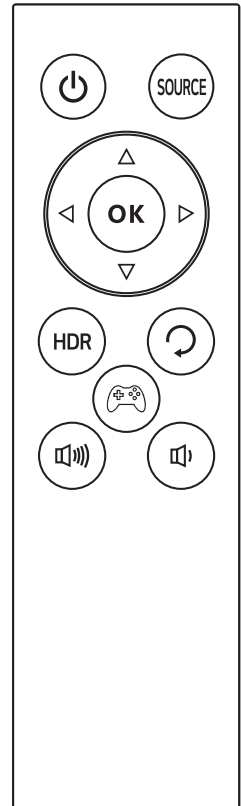

- Avoid pressing two remote buttons simultaneously as this may cause malfunctions.
- Avoid using the remote in areas with extreme temperature fluctuations.
- If the remote will not be used for extended periods of time, remove the battery.
- The remote control's range is approximately 16.4~23 ft. Use it within this range.
- Use 3V lithium battery (CR2032 or equivalent).
- Remember that small batteries are easily swallowed by young children. Keep batteries away from children. Call 911 if you believe a battery was ingested.

Cable connection

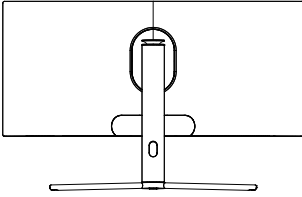

- * The bottom interface configuration at the back of the monitor varies with products.
- * Note: If the power cable or signal cable is damaged, you must replace it with special soft cables or special components purchased from the manufacture or maintenance department.

HDMI interface



Use the HDMI cable to connect the HDMI IN port of the product to the HDMI OUT port of a PC.

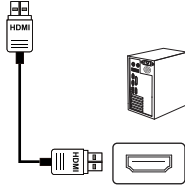

Use the HDMI-DVI cable (not included) to connect the HDMI IN port of the product to the DVI OUT port of a PC. (In general, PCs do not transfer video signals to the monitor through the DVI OUT interface, and it is necessary to connect a loudspeaker box additionally to play sounds of PCs.)



DP Port



Use the DP cable to connect the DP IN port of the product to the DP OUT port of a PC.

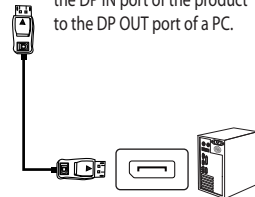

AUDIO OUT



Connect audio outputting devices such as earphones to the AUDIO OUT port.

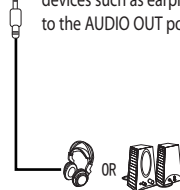

AC IN interface



Please connect the power cable plug to the corresponding port of the monitor, and connect the other end to a properly grounded power outlet.

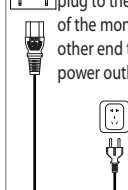

OSD menu

Menu description

- The color and shape of the OSD menu of the actual computer may be slightly different from them shown in the figure.
- Specifications of the OSD menu may change with improvements of functions without prior notice.

The screen display (OSD) menu can be used to adjust settings of the monitor and is shown on the screen after the monitor is powered on and the button is pressed.

1. Press one of the buttons () to activate the browser screen.

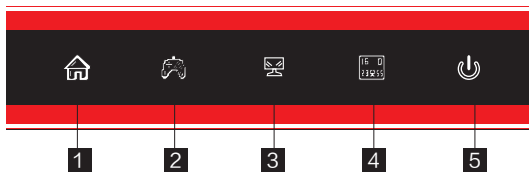

1	Confirm and enter the main menu
2	Game sight
3	Light console
4	Color format
5	Power ON/OFF

2. Press to enter the OSD screen.

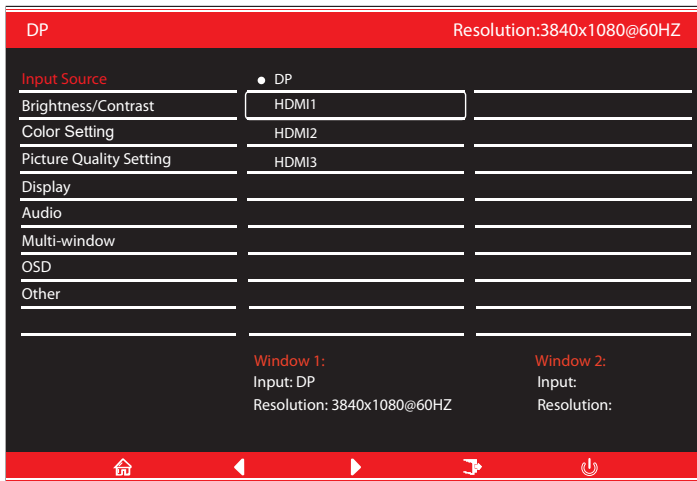

3. Press or to browse function.

- Select the desired function, and then press button to enter the submenu.
- Press or to browse the submenu, and then press button to confirm the selection of the desired function.
- Press or to select an item, then press button to confirm the settings and exit the current menu.

4. Press to exit the menu interface

• Functions of the monitor vary with models, and the functions in this manual are for reference only.

Input Source	DP	N/A
	HDMI1	N/A
	HDMI2	N/A
	HDMI3	N/A
Brightness/ Contrast	Brightness	0-100
	Blacklevel	0-100
	Contrast	0-100
	DCR	On/Off
Color Setting	Gamma	1.8/2.0/2.2/2.4/2.6
	Picture Mode	Standard/Photo/Movie/Game/FPS/RTS/USER
	Color Temperature	Warm/Cool/USER
	Low Blue Light	0-100
	Hue	0-100
	Saturation	0-100
Picture Quality Setting	Sharpness	0-100
	Response Time	Off/High/Middle/Low
	Noise Reduction	Off/High/Middle/Low
	Super Resolution	Off/High/Middle/Low
	Dynamic Luminous Control	On/Off
Display	Aspect Ratio	Wide Screen/4:3/1:1/Auto
Audio	Mute	On/Off
	Volume	0-100
	Audio Source	AutoSource/DP/HDMI1/HDMI2/HDMI3
Multi-window	Multi-Window	Off/PIP Mode/PBP 2Win
	Sub Win2 Input	DP/HDMI1/HDMI2/HDMI3
	PIP Size	Small/Medium/Large
	PIP Position	TopRight/Topleft/BottomRight/BottomLeft
	Swap	N/A
OSD	Language	English/简体中文/한국어/РУССКИЙ/Español/日本語/Francais
	OSD H-Position	0-100
	OSD V-Position	0-100
	OSD Transparency	0-100
	OSD Time Out	5-100
	OSD Rotation	Normal/90/180/270
Other	DP Version	DP1.1/DP1.2
	Adaptive-Sync	On/Off
	HDR	On/Off/Auto Detect
	Reset	N/A

Specification

Product Name		LCD Monitor
Product model		DGVIEW490
Screen Size		49 inch (124cm)
Aspect Ratio		32:9
Viewing Angle		178°(H) / 178°(V)
Pixel pitch		0.1038(H)× 0.3114(V)mm
Contrast ratio		3000:1(TYP)
Color		16.7M
Resolution		3840 x 1080
Refresh Rate		144Hz
Power Input		100-240V~ 50/60Hz, 2.0A The standard voltage and power supply may vary with countries, please refer to the label at the back of the product.
Product Dimensions	Without base	1198.54*375.6*160.2mm approx. X.XX kg
	With base	1198.5*471.0*245.7 mm approx. 11 kg
Tilting angle		Forward tilting-5°±2.0° ; Backward tilting+15°±2.0°
Height range		95±5mm
Rotation angle		-15°±2.0°/+15°±2.0°
Vertical angle		N/A
Environmental conditions	Action	Temperature: 0°C~ 40°C (32°F ~ 104°F) Humidity: 10%~90% RH (non-condensing)
	Storage	Temperature: -20°~ 60° (-4°F ~ 140°F) Humidity: 5%~95% RH (non-condensing)



The terms HDMI and HDMI High-Definition Multimedia Interface, and the HDMI Logo are trademarks or registered trademarks of HDMI Licensing Administrator, Inc. in the United States and other countries.

FC This device complies with Part 15 of the FCC Rules. Operation is subject to the following two conditions:(1)This device may not cause harmful interference, (2)This device must accept any interference received,including interference that may cause undesired operation.

Supported resolution and refresh rate

HDMI1[2.0]
Detailed Timing
3840x1080@60Hz
1920x1080@60Hz
2560x1080@60Hz
3840x1080@120Hz
Established Timing
720x400@70Hz-IBM.VGA
640x480@60Hz-IBM.VGA
640x480@75Hz-VESA
800x600@60Hz-VESA
800x600@75Hz-VESA
1024x768@60Hz-VESA
1024x768@75Hz-VESA
1280x1024@75Hz-VESA
Standard Timing
1152x864@75Hz-VESASTD
1280x720@60Hz-VESASTD
1280x960@60Hz-VESASTD
1280x1024@60Hz-VESASTD
1600x900@60Hz-VESASTD
1680x1050@60Hz-VESASTD
1920x1080@60Hz-VESASTD
Video Timing
[1]640x480p@59.94Hz@4:3@1:1
[2]720x480p@59.94Hz/60Hz@4:3@8:9
[3]720x480p@59.94Hz/60Hz@16:9@32:27
[4]1280x720p@59.94Hz/60Hz@16:9@1:1
[5]1920x1080i@59.94Hz/60Hz@16:9@1:1
[16]1920x1080p@59.94Hz/60Hz@16:9@1:1
[17]720x576p@50Hz@4:3@16:15
[18]720x576p@50Hz@16:9@64:45
[19]1280x720p@50Hz@16:9@1:1
[20]1920x1080i@50Hz@16:9@1:1
[31]1920x1080p@50Hz@16:9@1:1
[63]1920x1080p@119.88/120Hz@16:9@1:1
[89]2560x1080p@50Hz@64:27@1:1
[95]3840x2160p@29.97Hz/30Hz@16:9@1:1
[97]3840x2160p@59.94Hz/60Hz@16:9@1:1

HDMI2[1.4]
Detailed Timing
3840x1080@60Hz
1920x1080@60Hz
2560x1080@60Hz
Established Timing
720x400@70Hz-IBM.VGA
640x480@60Hz-IBM.VGA
640x480@75Hz-VESA
800x600@60Hz-VESA
800x600@75Hz-VESA
1024x768@60Hz-VESA
1024x768@75Hz-VESA
1280x1024@75Hz-VESA
Standard Timing
1152x864@75Hz-VESASTD
1280x720@60Hz-VESASTD
1280x960@60Hz-VESASTD
1280x1024@60Hz-VESASTD
1440x900@60Hz-VESASTD
1600x900@60Hz-VESASTD
1680x1050@60Hz-VESASTD
1920x1080@60Hz-VESASTD
Video Timing
[1]640x480p@59.94Hz@4:3@1:1
[2]720x480p@59.94Hz/60Hz@4:3@8:9
[3]720x480p@59.94Hz/60Hz@16:9@32:27
[4]1280x720p@59.94Hz/60Hz@16:9@1:1
[5]1920x1080i@59.94Hz/60Hz@16:9@1:1
[16]1920x1080p@59.94Hz/60Hz@16:9@1:1
[17]720x576p@50Hz@4:3@16:15
[18]720x576p@50Hz@16:9@64:45
[19]1280x720p@50Hz@16:9@1:1
[20]1920x1080i@50Hz@16:9@1:1
[31]1920x1080p@50Hz@16:9@1:1
[63]1920x1080p@119.88/120Hz@16:9@1:1
[89]2560x1080p@50Hz@64:27@1:1
[95]3840x2160p@29.97Hz/30Hz@16:9@1:1

HDMI2[1.4]
Detailed Timing
3840x1080@60Hz
1920x1080@60Hz
2560x1080@60Hz
Established Timing
720x400@70Hz-IBM.VGA
640x480@60Hz-IBM.VGA
640x480@75Hz-VESA
800x600@60Hz-VESA
800x600@75Hz-VESA
1024x768@60Hz-VESA
1024x768@75Hz-VESA
1280x1024@75Hz-VESA
Standard Timing
1152x864@75Hz-VESASTD
1280x720@60Hz-VESASTD
1280x960@60Hz-VESASTD
1280x1024@60Hz-VESASTD
1440x900@60Hz-VESASTD
1600x900@60Hz-VESASTD
1680x1050@60Hz-VESASTD
1920x1080@60Hz-VESASTD
Video Timing
[1]640x480p@59.94Hz@4:3@1:1
[2]720x480p@59.94Hz/60Hz@4:3@8:9
[3]720x480p@59.94Hz/60Hz@16:9@32:27
[4]1280x720p@59.94Hz/60Hz@16:9@1:1
[5]1920x1080i@59.94Hz/60Hz@16:9@1:1
[16]1920x1080p@59.94Hz/60Hz@16:9@1:1
[17]720x576p@50Hz@4:3@16:15
[18]720x576p@50Hz@16:9@64:45
[19]1280x720p@50Hz@16:9@1:1
[20]1920x1080i@50Hz@16:9@1:1
[31]1920x1080p@50Hz@16:9@1:1
[63]1920x1080p@119.88/120Hz@16:9@1:1
[89]2560x1080p@50Hz@64:27@1:1
[95]3840x2160p@29.97Hz/30Hz@16:9@1:1

DP2[1.4]
Detailed Timing
3840x1080@60Hz
3840x1080@120Hz
3840x1080@144Hz
2560x1080@60Hz
Established Timing
720x400@70Hz-IBM.VGA
640x480@60Hz-IBM.VGA
640x480@75Hz-VESA
800x600@60Hz-VESA
800x600@75Hz-VESA
1024x768@60Hz-VESA
1024x768@75Hz-VESA
1280x1024@75Hz-VESA
Standard Timing
1152x864@75Hz-VESASTD
1280x720@60Hz-VESASTD
1280x960@60Hz-VESASTD
1280x1024@60Hz-VESASTD
1600x900@60Hz-VESASTD
1680x1050@60Hz-VESASTD
1920x1080@60Hz-VESASTD
Video Timing
[1]640x480p@59.94Hz@4:3@1:1
[2]720x480p@59.94Hz/60Hz@4:3@8:9
[3]720x480p@59.94Hz/60Hz@16:9@32:27
[4]1280x720p@59.94Hz/60Hz@16:9@1:1
[5]1920x1080i@59.94Hz/60Hz@16:9@1:1
[16]1920x1080p@59.94Hz/60Hz@16:9@1:1
[17]720x576p@50Hz@4:3@16:15
[18]720x576p@50Hz@16:9@64:45
[19]1280x720p@50Hz@16:9@1:1
[20]1920x1080i@50Hz@16:9@1:1
[31]1920x1080p@50Hz@16:9@1:1
[63]1920x1080p@119.88/120Hz@16:9@1:1
[89]2560x1080p@50Hz@64:27@1:1
[95]3840x2160p@29.97Hz/30Hz@16:9@1:1
[96]3840x2160p@50Hz@16:9@1:1
[97]3840x2160p@59.94Hz/60Hz@16:9@1:1

Manufacturer's 1-Year Limited Warranty

The manufacturer warrants that all parts and components are defect free in materials and workmanship for 1 year. This warranty is valid only in accordance with the conditions set forth below:

1. The warranty extends only to the original consumer purchaser and is not transferable. In addition, proof of purchase must be demonstrated.
2. This limited warranty is the only written or express warranty given by the manufacturer. Any implied warranty of merchantability or fitness for a particular purpose on this product is limited in duration to the duration of this warranty. Some states do not allow limitations on how long an implied warranty lasts, so the above limitation may not apply to you.
3. This warranty gives you specific legal rights. You may also have other rights which vary by state.

Procedure for Replacement or Return within the 1 Year:

To return the product for replacement or refund within the 1 year, the original purchaser must pack the product securely and send it postage paid with a description of the reason for replacement or refund, proof of purchase, and include your order number on the package, to the following address:

Deco Gear
80 Carter Drive
Edison, NJ 08817

Other contact info

Phone: 844-413-2646
Customer Service Email: customerservice@decogear.com

dec  **gear**®

物料号码			
厂内型号	H3C2C-HQ	厂外型号	DGVIEW490
物料名称	说明书	品 牌	DECO GEAR
协力厂商		日 期	20211218
规 格	140x210mm		
要 求	封面封底157G铜版纸，内页80G铜版纸 彩印 骑马钉		
版 本	V01	设 计	蒋武波
确 认		核 准	