

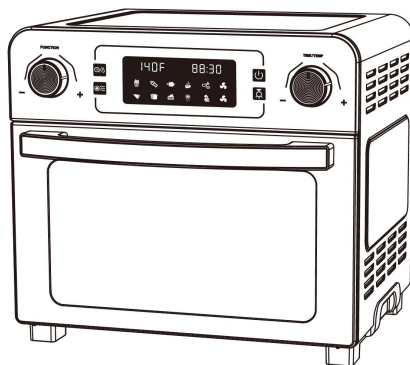

Instruction Manual

24 QT Toaster Oven Air Fryer

120V 60Hz 1700W



[View this product on decogear.com](http://decogear.com)

IMPORTANT SAFEGUARDS

When using an electrical appliance, basic safety precautions should always be followed, including the following:

1. Read all instructions.

2. Unplug from outlet when not in use and before cleaning.

Allow to cool before cleaning or handling, putting on or taking off parts.

3. Do not touch hot surfaces. Use handles, or knobs.

4. To protect against electrical shock, do not place any part of the Air Fryer Oven in water or other liquids. See instructions for cleaning.

5. This appliance should not be used by or near children or individuals with certain disabilities.

6. Do not operate any appliance with a damaged cord or plug, or after the appliance has malfunctioned or has been dropped or damaged in any way or is not operating properly. Return the Air Fryer Oven to the store or retailer where purchased for examination or repair, or adjustment.

7. The use of accessory attachments not recommended may cause injury.

8. Do not use outdoors.

9. Do not let cord hang over the edge of the table or countertop, where it could be pulled on inadvertently by children or pets, or touch hot surfaces, which could damage the cord.

10. Do not place Air Fryer Oven on or near a hot gas or electric burner or in a heated oven.

11. Do not use this Air Fryer Oven for anything other than its intended purpose.

12. Extreme caution should be exercised when using containers constructed of

materials other than metal or glass in the oven.

13. To avoid burns, use extreme caution when removing Air Fryer Oven accessories or disposing of hot grease.

14. When not in use, always unplug the unit. Do not store any materials other than manufacturer's recommended oven proof accessories in this Air Fryer Oven.

15. Do not place any of the following materials in the Air Fryer Oven: paper, cardboard, plastic and similar products.

16. Do not cover Crumb Tray or any part of the oven with metal foil. This will cause over heating of the oven.

17. Oversize foods, metal foil packages and utensils must not be inserted in the Air Fryer Oven, as they may involve a risk of fire or electric shock.

18. A fire may occur if the Air Fryer Oven is covered or touching flammable materials such as curtains, draperies or walls, when in operation. Do not store any items on top of the appliance when in operation. Do not to operate under wall cabinets.

19. Do not clean with metal scouring pads. Pieces can break off the pad and touch electrical parts, involving a risk of electric shock.

20. Do not attempt to dislodge food when the Air Fryer Oven is plugged into electrical outlet.

21. Warning: To avoid possibility of fire, NEVER leave Air Fryer Oven unattended during use.

22. Use recommended temperature settings for all cooking/baking, roasting and Air Frying.

23. Do not rest cooking utensils or baking dishes on glass door.

24. Turn the ON/Oven Timer and the ON/Toaster Timer dials to the OFF position to turn off the Air Fryer Oven.
25. Do not operate your appliance in an appliance garage or under a wall cabinet. When storing in an appliance garage, always unplug the unit from the electrical outlet. Not doing so could create a risk of fire, especially if the appliance touches the walls of the garage or the door touches the unit as it closes.
26. Extreme caution must be used when moving an appliance containing hot oil or other hot liquids.
27. To disconnect, turn any control to "off", then remove plug from wall outlet.
28. A fire may occur if the Air Fryer Oven is covered or touching flammable material, including curtains, draperies, walls, and the like, when in operation. Do not store any item on top of the appliance when in operation.

SAVE THESE INSTRUCTIONS

Please read and keep these instructions handy. These instructions will help you use your Air Fryer Oven to its fullest so that you will achieve consistent, professional results.

SPECIAL CORD SET INSTRUCTIONS

A short power-supply cord is provided to reduce the risks resulting from becoming entangled in or tripping over a longer cord. Extension cords are available and may be used if care is exercised in their use. If an extension cord is used, the marked electrical rating of the extension cord must be at least as great as the electrical rating of the appliance, and the longer cord should be arranged so that it will not drape over the countertop or tabletop, where it can be tripped over unintentionally or pulled on by children.

FOR HOUSEHOLD USE ONLY

NOT INTENDED FOR COMMERCIAL USE

Parts and Accessories:

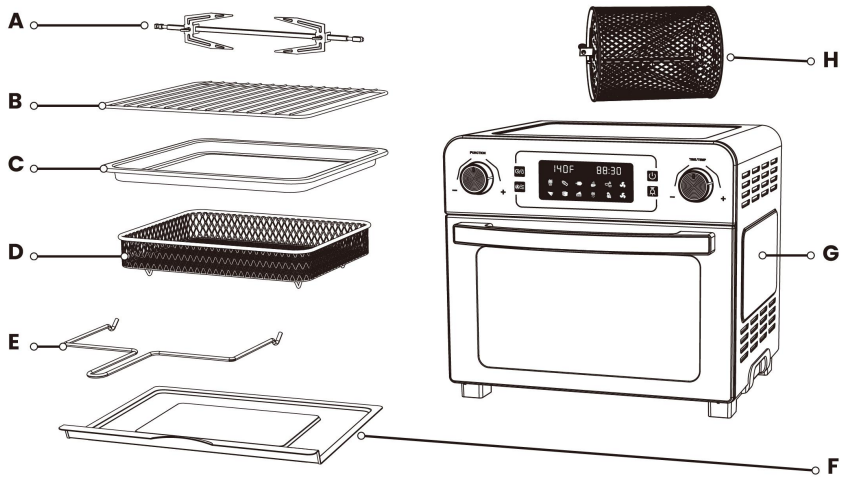

A. Rotisserie assembly

B. Wire rack

C. Baking pan/drip pan

D. Air fryer basket

E. Fetching rack

F. Removable crumb tray

G. Air fryer oven

H. Rolling cage

A: Rotisserie Shaft, Forks & Set Screws

Use for roasts and whole chickens. Force shaft lengthwise through meat and center. Slide Forks onto shaft from either end into meat, then lock in place with Set Screws. There are indentations on the shaft for the set screws. You can adjust the screws closer to the middle if needed but never outward towards the ends.

B: Wire rack

The Wire Rack can be used in three rack positions, bottom, middle, and top.

C: Baking pan

The Baking/Drip Pan can be placed in any of the three rack positions.

D: Air fryer basket

The Air Fryer Basket is grated to allow air to pass through the basket for even cooking. The Air Fryer Basket can only be used in conjunction with either the Baking/Drip Pan or the Wire Rack. The Air Fryer Basket should be placed in the middle rack position unless a recipe states otherwise.

E: Fetch rack

The Fetch Rack is used to remove a rotisserie chicken.

F: Removable crumb tray

The Removable Crumb Tray slides out from the bottom front of the Air Fryer Oven for easy cleaning. Always ensure that the Removable Crumb Tray is placed underneath the bottom heating elements whenever the oven is being used.

H: Rolling cage

Use for popcorn or french fry.

Features and benefits

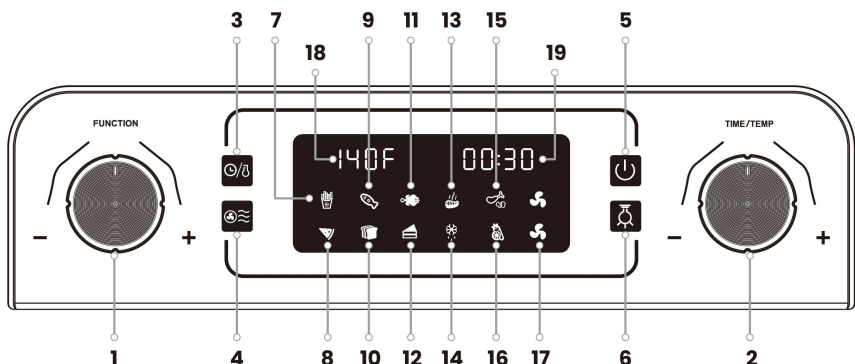

1. Function selection knob

Use to select different functions.

2. Temperature/Time adjusting knob

Use to adjust desired time and temperature.

3. Time / Temperature adjust mode switch button

Use to select either time or temperature for adjusting.

4. Fan speed adjust

The oven has two fan speeds, low or high, press this button can switch the fan speed between low and high, one fan icon light on when fan works with low speed, two fan icons light on together under fan works with high speed.

5. Start/ Stop button









Use to start or stop the oven after set well.

6. Oven light

Press this button to turn the Oven Light On or Off.

Functions general review.

NO.	function name	Icon	temperature (°F)	time (mins)	fan speed
7	French Fries		450	15	high

8	Pizza		450	7	low
9	Fish		450	25	low
10	Toast		450	5	low
11	Rotisseries		350	45	low
12	Bake		350	35	low
13	Steak		450	8	low
14	Warm		140	30	low
15	Chicken		450	18	high
16	Dehydrate		140	60	low

17. Fan speed indication icon

Works with low fan speed, upper icon light on; works with high fan speed, two

fan icons light on together.

18. Temperature display

Digital display for working of temperature.

19. Time display

Digital display for working time.

Oven Rack

There are 3 rack positions: top, middle and bottom.

Top position

Middle position

Bottom position

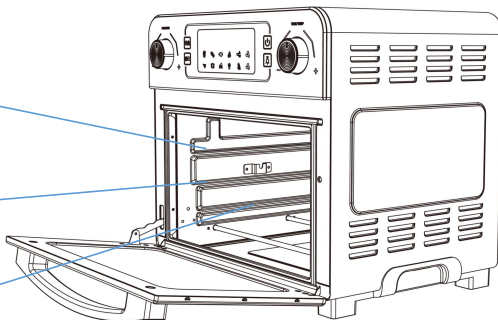

Before First Use

- Unpack the Air Fryer Oven and remove all packaging materials.

Clean the Air Fryer Oven according to the Care & Cleaning section of this manual.

- Place the Air Fryer Oven, on a flat, stable, level surface. Ensure that the oven is 2 to 4 inches away from the wall or any other objects.
- We recommend performing a trial run of your Air Fryer Oven to eliminate any protective substance from the heating elements. Conduct the trial run in a well-ventilated area as a small amount of smoke and odor may be detected. This is normal and should be expected.



Operating your Oven

Note:

1. Under each function mode, the time and temperature can be adjusted. If you need a different time and/or temperature, press Time/Temperature adjust mode button on the top left of the display window. Press once and the temperature display will flash - then turn the knob on right side to adjust temperature. If you want to adjust the time, press the button again. With the second press, the oven enters into cooking time adjust mode. The time display will flash and you can then turn knob on the right side to set desired time.
2. Fan speed: The oven has a unique fan speed adjustment feature. Under each function mode the oven has a default fan speed. If you want to change the fan speed, press speed selection button to get your desired setting.

French Fries

1. Place the Air Fryer Oven, on a flat, stable, level surface. Ensure that the oven is 2 to 4 inches away from the wall or any other objects.
2. Ensure that the Removable Crumb Tray is placed beneath the bottom heating elements when using your Air Fryer Oven.
3. The Air Fryer Basket can be placed on top of the Wire Rack or in the Baking/Drip Pan. Use the Air Fryer function in the middle or bottom rack position of the oven.
4. Plug on the oven with power, LED shows OFF. In this mode, any knob turn or start/stop button press can activate machine into standby mode.
5. Turn function knob, select the French Fries function. In this mode, time and temperature, fan speed display as bellow.

function name	Icon	temperature (°F)	time (mins)	fan speed
French Fries		450	15	

6. Press start/stop button to turn on the oven. The French fries icon will flash, the remaining icons shut off.



When the set time has expired, the display screen shows OFF.

Note: the time/ temperature as well as fan speed can be adjusted as desired.

7. Unplug from the wall outlet when not using the oven.

Pizza

1. Place the Air Fryer Oven, on a flat, stable, level surface. Ensure that the oven is 2 to 4 inches away from the wall or any other objects.
2. Ensure that the Removable Crumb Tray is placed beneath the bottom heating elements when using your Air Fryer Oven.
3. Place pizza on the wire rack; then place wire rack in middle rack position.
4. Plug on the oven with power, LED shows OFF. Under this mode, any knob turn or start/ stop button press can activate machine entering into be standby mode.
5. Turn function knob, select the function of pizza, under this mode, time and temperature, fan speed display as bellow.

function name	Icon	temperature (°F)	time (mins)	fan speed
Pizza		450	7	

6. Press start/stop button, turn on the oven. The pizza icon will icon will flash, the remaining icons shut off.



When the set time has expired, display screen shows OFF.

Note: the time/ temperature as well as fan speed can be adjusted as desired.

7. Unplug from the wall outlet when not using the oven.

Fish

1. Place the Air Fryer Oven, on a flat, stable, level surface. Ensure that the oven is 2 to 4 inches away from the wall or any other objects.
2. Ensure that the Removable Crumb Tray is placed beneath the bottom heating elements when using your Air Fryer Oven.
3. Place food on the wire rack; then place wire rack in middle rack position.
4. Plug on the oven with power, LED shows OFF. Under this mode, any knob turn or start/ stop button press can activate machine entering into be standby mode.
5. Turn function knob, select the function of fish, under this mode, time and temperature, fan speed display as bellow.

function name	Icon	temperature (°F)	time (mins)	fan speed
Fish		450	25	

6. Press start/stop button, turn on the oven. The fish icon will flash, the remaining icons shut off.



When the set time has expired, display screen shows OFF.

Note: the time/ temperature as well as fan speed can be adjusted as desired.

7. Unplug from the wall outlet when not using the oven.

Toast

1. Place the Air Fryer Oven, on a flat, stable, level surface. Ensure that the oven is 2 to 4 inches away from the wall or any other objects.
2. Ensure that the Removable Crumb Tray is placed beneath the bottom heating elements when using your Air Fryer Oven.
3. Place bread on the wire rack; then place wire rack in middle rack position.
4. Plug on the oven with power, LED shows OFF. Under this mode, any knob turn or start/ stop button press can activate machine entering into be standby mode.
5. Turn function knob, select the function of toast, under this mode, time and temperature, fan speed display as bellow.

function name	Icon	temperature (°F)	time (mins)	fan speed
Toast		450	5	

6. Press start/stop button, turn on the oven. The toast icon will flash, the remaining icons shut off.

When the set time has expired, display screen shows OFF.

Note: the time/ temperature as well as fan speed can be adjusted as desired.

7. Unplug from the wall outlet when not using the oven.

Rotisseries

1. Place the Air Fryer Oven, on a flat, stable, level surface. Ensure that the oven is 2 to 4 inches away from the wall or any other objects.
2. Ensure that the Removable Crumb Tray is placed beneath the bottom heating elements when using your Air Fryer Oven.
3. Place one Rotisserie Fork on the end of the Rotisserie Spit with the Fork facing the center and tighten the Rotisserie Screw.
4. Slide the solid end of the Rotisserie Spit through the center of the food to be cooked.
5. Place the other Rotisserie Fork on the other end of the Rotisserie Spit with the Rotisserie Fork facing the roast.
6. Adjust the roast so that it is centered on the Rotisserie Spit. Make sure the Rotisserie Forks secure the roast on the Rotisserie Spit and tighten the Rotisserie Screws.
7. When cooking poultry, it is necessary to secure legs and wings to the body with string to make the roast as compact as possible for smooth movement of the Rotisserie Spit (see trussing instructions).
8. Season or baste the roast as desired.
9. Put the solid end (Right Side - see Figure 1) of the Rotisserie Spit in the drive socket on right interior wall of the oven.

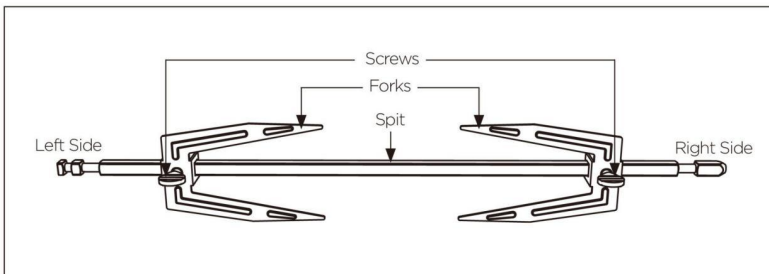



Figure 1

10. Place the grooved end (Left Side - see Figure 1) of the Rotisserie Spit on the left interior wall of the oven.

11. Plug on the oven with power, LED shows OFF. Under this mode, any knob turn or start/ stop button press can activate machine entering into be standby mode.

12. Turn function knob, select the function of rotisseries, under this mode, time and temperature, fan speed display as bellow.

function name	Icon	temperature (°F)	time (mins)	fan speed
Rotisseries		350	45	

13. Press start/stop button, turn on the oven. The rotisseries icon will flash, the remaining icons shut off.

When the set time has expired, display screen shows OFF.

14. Unplug from the wall outlet when not using the oven.

15. Remove the roast from the oven using the Rotisserie Removal Tool by placing the tool underneath the grooved edges of the Spit. Lift the left side up and towards you at an angle and slide the right side of the Spit out of the Rotisserie Socket.

16. Place the roast on a cutting board or platter and allow to stand for 10-15 minutes.

17. Using a pot holder, loosen the Rotisserie Screws on the Rotisserie Forks and remove the Rotisserie Spit from the roast.

18. Carefully remove the Rotisserie Forks and carve the roast.

Trussing Poultry



1 Place the poultry on a cutting board breast up. Place twine under the wings then pull the twine evenly between legs and breast.

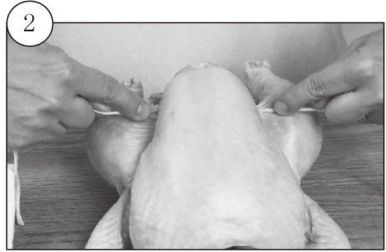

2 Cross the twine.



3 Run the twine under the end of the legs.

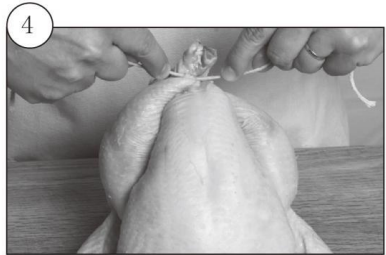

4 Wrap the twine up and around legs, bring them together then tie the twine into a knot and a bow to secure.





5 Run rotisserie rod through the cavity of the poultry. Secure the rotisserie fork between the legs and into the back of the poultry then tighten down the screw on the rotisserie fork.



6 Place the other rotisserie fork on the rotisserie rod already inserted. Slide down and secure the rotisserie fork into both sides of the breast. Tighten down the screw on the rotisserie rod. Load into the oven.

Bake

1. Place the Air Fryer Oven, on a flat, stable, level surface. Ensure that the oven is 2 to 4 inches away from the wall or any other objects.
2. Ensure that the Removable Crumb Tray is placed beneath the bottom heating elements when using your Air Fryer Oven.
3. Use the Wire Rack on the Baking/Drip Pan when using the Bake function. You can also use bakeware or any oven-safe glassware in your oven if the dimensions do not exceed 12"x12". Only use the Bake function in the middle or bottom rack position of the oven.
4. Plug on the oven with power, LED shows OFF. Under this mode, any knob turn or start/ stop button press can activate machine entering into be standby mode.
5. Turn function knob, select the function of bake, under this mode, time and temperature, fan speed display as bellow.

function name	Icon	temperature (°F)	time (mins)	fan speed
Bake		350	35	

6. Press start/stop button, turn on the oven. The bake icon will flash, the remaining icons shut off.



When the set time has expired, display screen shows OFF.

Note: the time/ temperature as well as fan speed can be adjusted as desired.

7. Unplug from the wall outlet when not using the oven.

Steak

1. Place the Air Fryer Oven, on a flat, stable, level surface. Ensure that the oven is 2 to 4 inches away from the wall or any other objects.
2. Ensure that the Removable Crumb Tray is placed beneath the bottom heating elements when using your Air Fryer Oven.
3. Place the Baking/Drip Pan in the middle position of the oven.
4. Plug on the oven with power, LED shows OFF. Under this mode, any knob turn or start/ stop button press can activate machine entering into be standby mode.
5. Turn function knob, select the function of steak, under this mode, time and temperature, fan speed display as bellow.

function name	Icon	temperature (°F)	time (mins)	fan speed
Steak		450	8	

6. Press start/stop button, turn on the oven. The steak icon will flash, the remaining icons shut off.



When the set time has expired, display screen shows OFF.

Note: the time/ temperature as well as fan speed can be adjusted as desired.

7. Unplug from the wall outlet when not using the oven.

Warm

1. Place the Air Fryer Oven, on a flat, stable, level surface. Ensure that the oven is 2 to 4 inches away from the wall or any other objects.
2. Ensure that the Removable Crumb Tray is placed beneath the bottom heating elements when using your Air Fryer Oven.
3. Place the Baking/Drip Pan in the middle position of the oven
4. Plug on the oven with power, LED shows OFF. Under this mode, any knob turn or start/ stop button press can activate machine entering into be standby mode.
5. Turn function knob, select the function of warm, under this mode, time and temperature, fan speed display as bellow.

function name	Icon	temperature (°F)	time (mins)	fan speed
Warm		140	30	

6. Press start/stop button, turn on the oven. The warm icon will flash, the remaining icons shut off.



When the set time has expired, display screen shows OFF.

Note: the time/ temperature as well as fan speed can be adjusted as desired.

7. Unplug from the wall outlet when not using the oven.

Chicken

1. Place the Air Fryer Oven, on a flat, stable, level surface. Ensure that the oven is 2 to 4 inches away from the wall or any other objects.
2. Ensure that the Removable Crumb Tray is placed beneath the bottom heating elements when using your Air Fryer Oven.
3. Place the Baking/Drip Pan in the middle position of the oven
4. Plug on the oven with power, LED shows OFF. Under this mode, any knob turn or start/ stop button press can activate machine entering into be standby mode.
5. Turn function knob, select the function of chicken, under this mode, time and temperature, fan speed display as bellow.

function name	Icon	temperature (°F)	time (mins)	fan speed
Chicken		450	18	

6. Press start/stop button, turn on the oven. The chicken icon will flash, the remaining icons shut off.



When the set time has expired, display screen shows OFF.

Note: the time/ temperature as well as fan speed can be adjusted as desired.

7. Unplug from the wall outlet when not using the oven.

Dehydrate

1. Place the Air Fryer Oven, on a flat, stable, level surface. Ensure that the oven is 2 to 4 inches away from the wall or any other objects.
2. Ensure that the Removable Crumb Tray is placed beneath the bottom heating elements when using your Air Fryer Oven.
3. Place the air fry basket in the middle position of the oven. Arrange food evenly on the included air fry basket. For best results, place food in a single layer and leave space between pieces.
4. Plug on the oven with power, LED shows OFF. Under this mode, any knob turn or start/ stop button press can activate machine entering into be standby mode.
5. Turn function knob, select the function of dehydrate, under this mode, time and temperature, fan speed display as bellow.

function name	Icon	temperature (°F)	time (mins)	fan speed
Dehydrate		140	60	

6. Press start/stop button, turn on the oven. The dehydrate icon will flash, the remaining icons shut off.

When the set time has expired, display screen shows OFF.

Note: the time/ temperature as well as fan speed can be adjusted as desired.

7. Unplug from the wall outlet when not using the oven.

Care & Cleaning

- Unplug your Air Fryer Oven and allow it to completely cool before cleaning. Do not use abrasive cleaners, as they will damage the finish. Simply wipe the exterior with a clean, damp cloth and dry thoroughly. Apply the cleaning agent to a cloth, not directly onto the Air Fryer Oven. Do not use excess pressure when cleaning the area of the control panel as it could cause the text to be removed over time.
- To clean the interior walls and bottom of the oven (remove the Removable Crumb Tray first) use a damp soapy cloth or sponge. Never use harsh abrasives or corrosive products including oven cleaner sprays. These could damage the oven surface. Never use steel wool pads on the Air Fryer Oven or accessories.
- The Wire Rack, Baking/Drip Pan, Air Fryer Basket and Removable Crumb Tray should be hand-washed in hot, sudsy water or use a nylon scouring pad or nylon brush. These parts are not dishwasher safe.
- Always clean the Removable Crumb Tray after each use. Excess food particles could cause smoking and will be hard to remove from tray. To remove baked-on grease or burnt food particles you can soak the Removable Crumb Tray in hot, sudsy water or use nonabrasive cleaners. Never operate the oven without the Removable Crumb Tray in place.
- The Rotisserie Spit, Forks, Screws and Removal Tool can be cleaned with a cloth or sponge in hot, sudsy water. For stubborn stains soak them in hot sudsy water prior to cleaning.
- The top interior of the Air Fryer Oven should be cleaned to remove excess grease that may accumulate after cooking greasy foods or after using the rotisserie function. Doing so will prevent smoking in the oven during subsequent uses.



Manufacturer's 1-Year Limited Warranty

The manufacturer warrants that all parts and components are defect free in materials and workmanship for 1 year. This warranty is valid only in accordance with the conditions set forth below:

1. The warranty extends only to the original consumer purchaser and is not transferable. In addition, proof of purchase must be demonstrated.
2. This limited warranty is the only written or express warranty given by the manufacturer. Any implied warranty of merchantability or fitness for a particular purpose on this product is limited in duration to the duration of this warranty. Some states do not allow limitations on how long an implied warranty lasts, so the above limitation may not apply to you.
3. This warranty gives you specific legal rights. You may also have other rights which vary by state

Procedure for Replacement or Return within the 1 Year:

To return the product for replacement or refund within the 1 year, the original purchaser must pack the product securely and send it postage paid with a description of the reason for replacement or refund, proof of purchase, and include your order number on the package, to the following address:

Deco Chef
80 Carter Drive
Edison, NJ 08817