

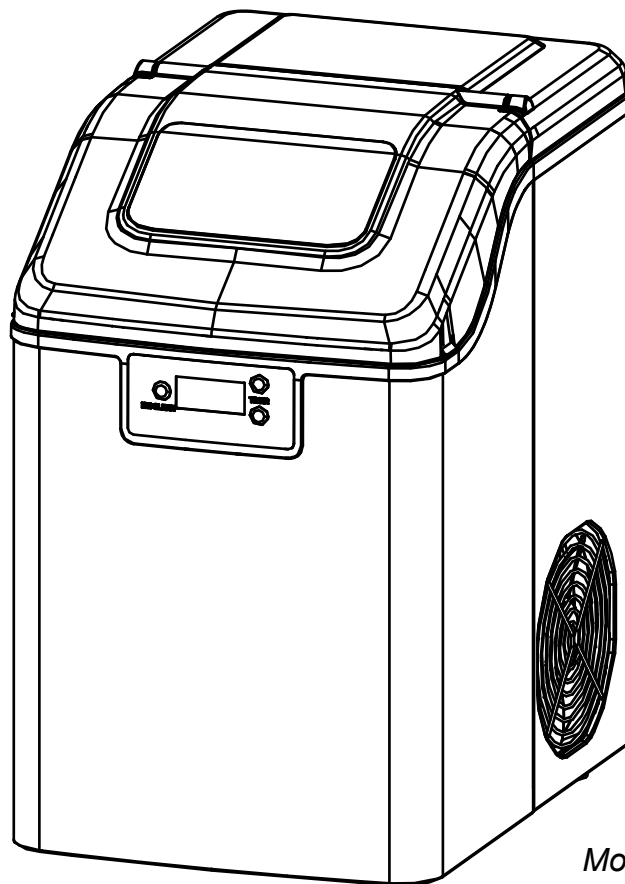

USER MANUAL

PORTABLE NUGGET ICE MAKER



*Model: DGIM44NGBLK
DGIM44NGSTS*

It is important that you read these instructions before using your portable ice maker and we strongly recommend that you keep them in a safe place for future reference.

TABLE OF CONTENTS

IMPORTANT SAFETY INSTRUCTIONS	2
PREPARING YOUR ICE MAKER FOR USE	
IMPORTANT SAFETY TIPS.....	2
GETTING TO KNOW YOUR UNIT	3
OPERATING PROCEDURES & MAINTENANCE	
UNPACKING YOUR ICE MAKER.....	4
CONNECTING YOUR ICE MAKER.....	4
CLEANING AND MAINTAINING YOUR ICE MAKER.....	4
USING YOUR ICE MAKER	5
TROUBLESHOOTING.....	9
TECHNICAL PARAMETERS & CIRCUIT DIAGRAM	10
TECHNICAL PARAMETERS	10
CIRCUIT DIAGRAM	10
DISPOSAL AND WARRANTY INFORMATION	11

IMPORTANT SAFETY INSTRUCTIONS

Your safety and the safety of others are very important.

We have provided many important safety messages in this manual for your appliance

Always read and obey all safety messages.

This is the safety alert symbol:



All safety messages will follow the safety alert symbol and the word “DANGER” or “WARNING”.



These words mean:

You can be killed or seriously injured if you don't immediately follow instructions.

All safety messages will tell you what the potential hazard is, tell you how to reduce the chance of injury, and tell you what can happen if the instructions are not followed.

PREPARING YOUR ICE MAKER FOR USE

When using electrical appliances, basic safety precautions should be followed to reduce the risk of fire, electric shock, and injury to persons or property. Read all instructions before using any appliance.

- Do not operate this, or any other appliance with a damaged cord.
If the supply cord is damaged, it must be replaced by the manufacturer or its service agent or a similarly qualified person in order to avoid a hazard.
This ice-maker must be positioned so that the plug is accessible.
Connect to properly grounded outlets only. No other appliance should be plugged into the same outlet. Be sure that the plug is fully inserted into the receptacle.
- Do not run the power cord over carpeting or other heat insulators. Do not cover the cord. Keep cord away from traffic areas, and do not submerge in water.
- We do not recommend the use of an extension cord, as it may overheat and become a risk of fire. If you must use an extension cord, use No.14AWG minimum size and rated no less than 1875 watts.
- Unplug the ice maker before cleaning or making any repairs or servicing.
- Exercise caution and use reasonable supervision when appliance is used near children.
- Do not use your ice-maker outdoors. Place the ice-maker away from direct sunlight and make sure that there is at least 6 inches of space between the back of your unit and wall. Keep a minimum distance of 6 inches on each side of your unit free.

- Do not use other liquid to make the ice-cube other than water.
- Do not clean your ice maker with flammable fluids. The fumes can create a fire hazard or explosion.
- Do not tip over.
- If the ice maker is brought in from outside in wintertime, give it a few hours to warm up to room temperature before plugging it in.

WARNING: This appliance must be grounded

IMPORTANT:

The wires in this mains lead are colored in accordance with the following code:

Green or Green with a strip yellow:	Grounding
White:	Neutral
Black:	Live

To avoid a hazard due to instability of the appliance, it must be placed at an even or flat surface.

GETTING TO KNOW YOUR UNIT

1. Ice basket
2. Top cover, removable from the top
3. Secondary water reservoir: It connects directly with the evaporator.
4. Float switch.
5. Metal shell:
6. Water drain cap: at front btm side of the unit.
7. Filter
8. Control Panel
9. Water reservoir
10. Hot Air outlet
11. MAXIMUM WATER LEVEL: —▼—

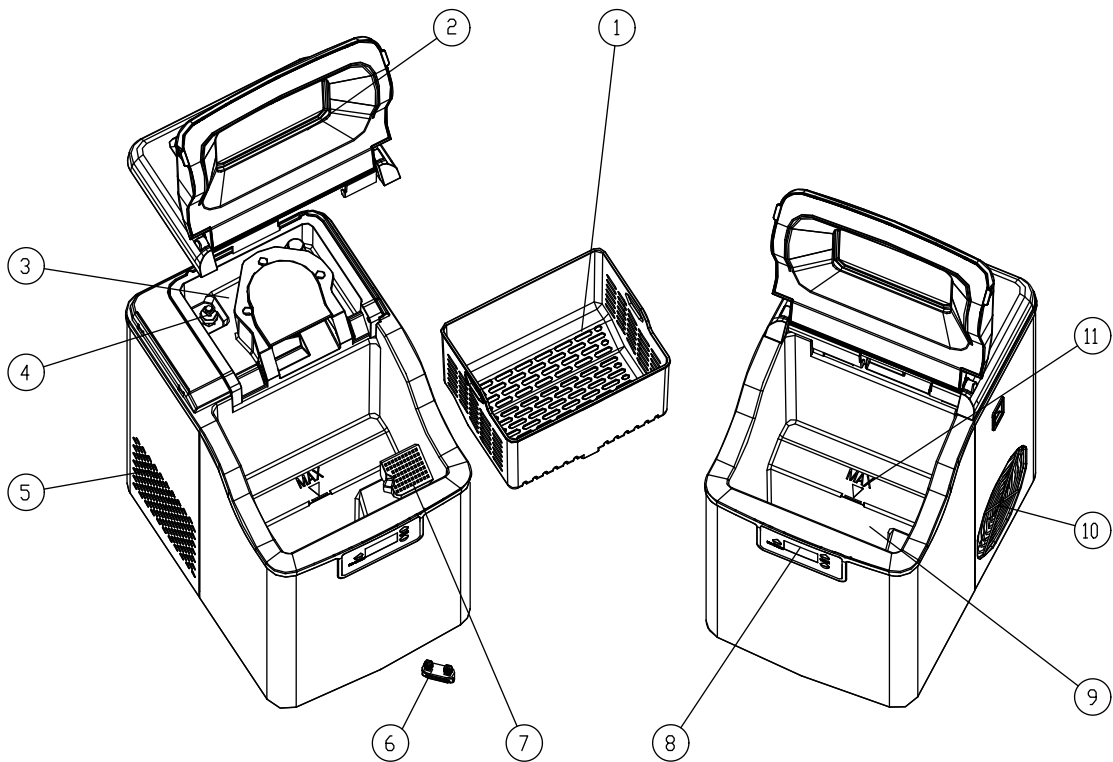

OPERATING PROCEDURES & MAINTENANCE

1. Remove the exterior and interior packaging, and then check all the accessories are included. If any parts are missing, please contact our customer service.
2. Remove all the tapes on the unit; take out the accessory parts inside.
3. Clean the interior with lukewarm water and a soft cloth.
4. Locating your ice maker on a level counter table far from direct sunlight and other sources of heat (i.e.: stove, furnace, and radiator). Make sure that there is at least 6 inches between the back and sides of your ice maker with the wall.
5. Allow one hour for the refrigerant fluid to settle down before plugging your ice maker in.
6. The power plug must be accessible directly.

WARNING: fill with potable water only. Only use drinking water.



DANGER

***Improper use of the grounded plug can result in the risk of electrical shock. If the power cord is damaged, please call our customer service.**

1. This unit should be properly grounded for your safety. The power cord of this appliance is equipped with a grounding plug which mates with standard grounding wall outlets to minimize the possibility of electric shock.
2. Plug your appliance into an exclusive, properly installed, grounding wall outlet. Do not under any circumstances; damage the grounding means of the plug. Any questions concerning power and/or grounding should be directed toward a certified electrician.
3. This appliance requires a standard 110-120Volt, 60Hz electrical outlet with good grounding means.

Before using your ice maker, it is strongly recommended to clean it thoroughly.

Unplug the unit before cleaning or making any maintenance.

1. Take out the ice basket.
2. Clean the interior with diluted detergent, warm water and a soft cloth.
3. Then use the water to rinse the inside parts, and drain out the water by unplugging the drain cap on front bottom side.
4. The outside of the ice maker should be cleaned regularly with a mild detergent solution and warm water.
5. Dry the interior and exterior with a clean soft cloth.
6. When the machine is not to be used for a long time, drain water completely & dry the interior.

USING YOUR ICE MAKER

How to start the unit

1. Take out the ice basket, pour potable water into water reservoir, 0.58 gallon (2.2 liters) water at most at one time.
2. Put back the ice basket.
3. Plug in the power cord.

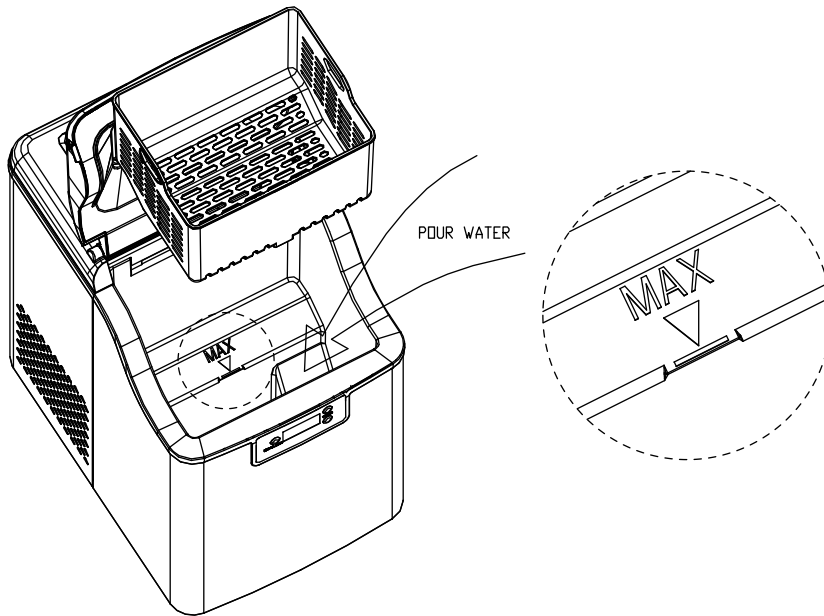

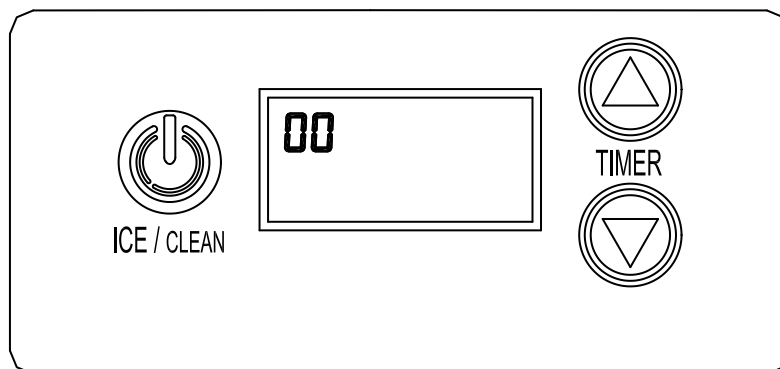

Operation and display areas



Plug in the power cord, the screen is on: you can operate this appliance by touch the button on panel as shown above, the main function includes: ice, clean and timer.

CLEAN

For the first time, or the clean procedure has not been running for a long time, it is highly recommended to run this procedure at first.

4. Before clean procedure, please make sure the water drain cap has been inserted into the appliance; otherwise it will not work properly.
5. Press “ICE/CLEAN” button “” for 5 seconds, the screen displays 15M and the “CLEAN” symbol “” (as shown in the figure below), it will run cleaning procedure for 15 minutes and automatically exit, press this button again during the cleaning procedure, it will exit immediately.

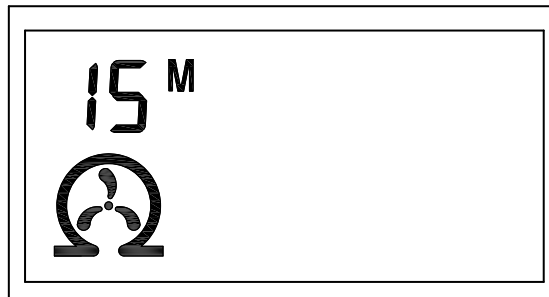

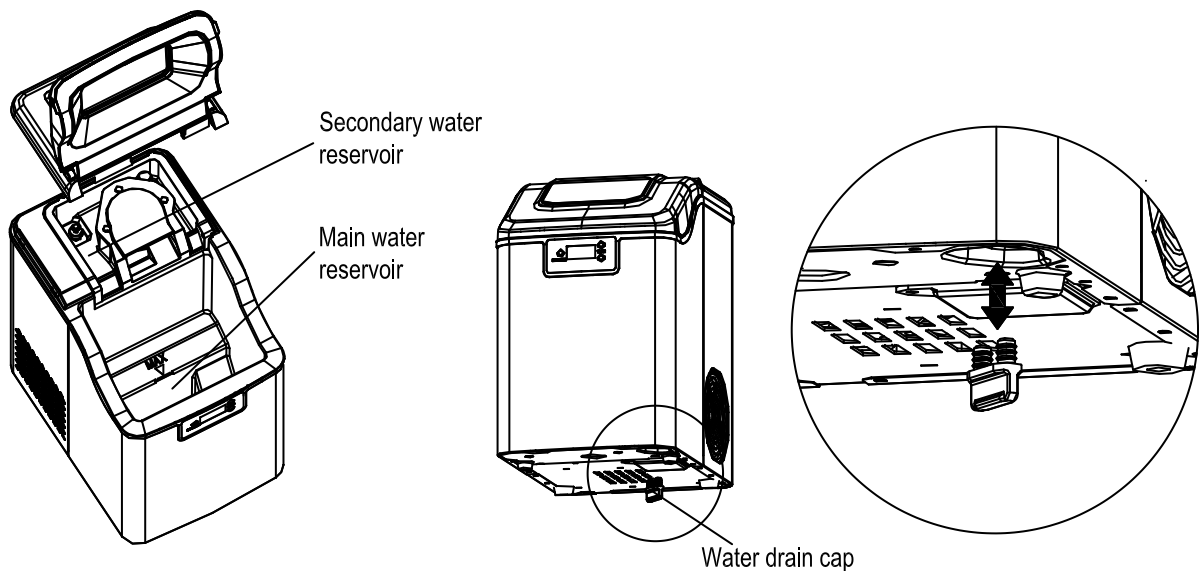

6. After cleaning procedure, remove the top cover and the ice basket, rinse the main water reservoir and the secondary water reservoir, then move the appliance to the edge of the desktop, make sure that the appliance is placed steady, place a water container under the appliance, remove drain cap from the bottom, dirty water will drain into the water container, then reinsert the drain cap.





Change water in the water reservoir every 24 hours to ensure a reasonable hygiene level. If the unit isn't to be used, drain all water & dry the water reservoir.

How to obtain the ice-cube

7. Before we start making ice, please make sure the water drain cap has been inserted into the appliance; otherwise it will not work properly.

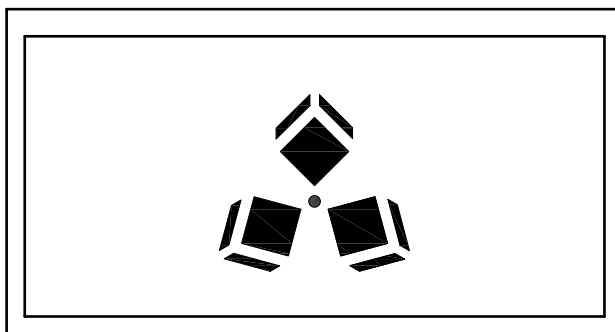
8. Press “ICE/CLEAN” button , the screen displays “ICE” symbol  (as shown in the figure below) , it begin to work, Press this button again, it will stop making ice.



9. For the first time, or if the appliance has not been used for a long time, it is recommended to clean this appliance before you start to make ice.
10. While the ice-maker is on, verify water level periodically. If water pump can't pump out water, the ice maker will stop automatically, and the “Add water” symbol  will appear (as shown in the figure below). Need to pour water into the water reservoir inside.

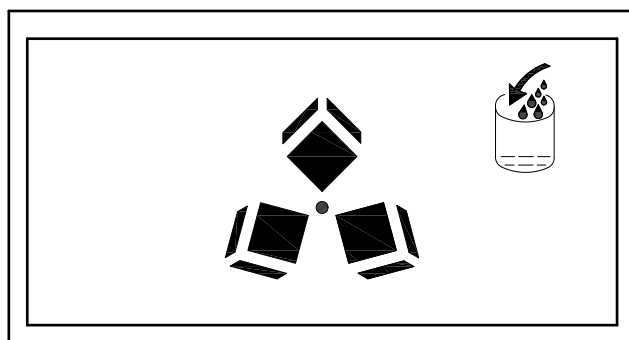

11. The ice maker automatically stops working when the ice-cube is full inside and the “ice full” symbol  appears(as shown in the figure below).

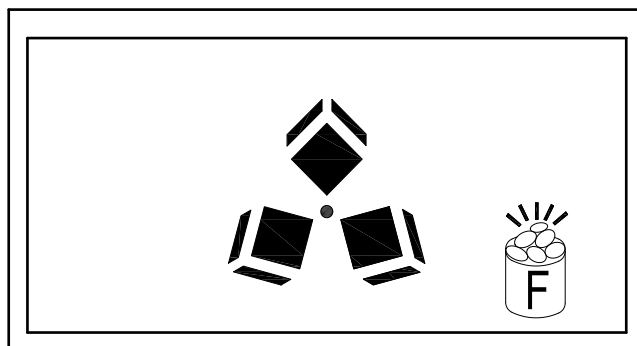

How to set the timer

Timer Delay Time Range: 0-24 hours

Press once to change: 1H

When the unit is running, you can set the unit with OFF-TIMER to let the unit stop running after your set delay time.

And when the unit is on standby, you can set the unit with ON-TIMER to let the unit start to run automatically after your set delay time, then when you go back home or have a dinner, you can enjoy the happy life that this ice-maker give to you.

12. Press the "TIMER" button "▲" or "▼" to start setting timing, then press the "▲" button to increase the time, and press the "▼" button to decrease the time. Press the "TIMER" button in standby mode, it will startup after the countdown (as shown in the figure a); Press the "TIMER" button in Ice-making mode, it will shutdown after the countdown (as shown in the figure b).

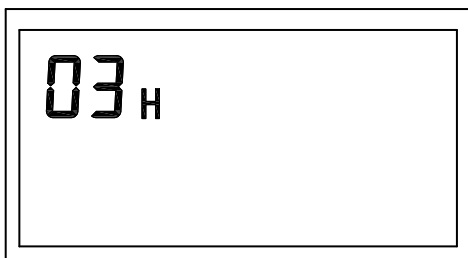

a. (Start ice making in three hours)

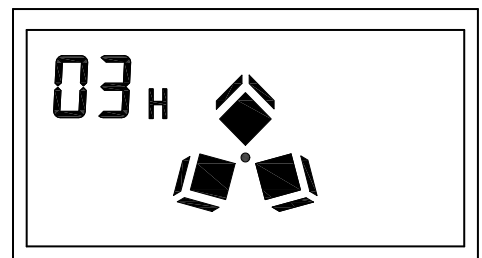



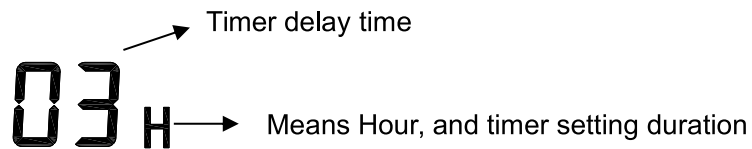

b.(Exit ice making after three hours)

13. When the unit has been set with the timer, press the TIMER button, then the delay time digit and "H" letter display will disappear, mean the timer set has been canceled.



Tips: The background light on the screen automatically goes out after 30 seconds without operation, if you want to keep the light on, press the "TIMER" button "▲" for 5 seconds; And if you want to cancel the constant light, press the "TIMER" button "▲" for 5 seconds again.

TROUBLESHOOTING

PROBLEM	POSSIBLE CAUSE	SOLUTION
 <p>“” symbol is lightening on and the arrow flashes.</p>	Lack of Water.	Stop the ice maker, fill water, and press “ICE/CLEAN” button again to restart the unit.
 <p>“” symbol is lightening and letter “F” flashes.</p>	There is too much ice.	Suggest you to obtain the ice-cube.
	(No ice cube inside).	Remove the probable obstacle inside or clean the inside wall of the ice storage Press “ICE/CLEAN” button for 5 seconds , it will work for 80 minutes.
E1	Ambient temperature or water temperature in inner tank is too high.	Please run the ice maker below 90 Fahrenheit degree ambient and pour colder water into tank.
	Refrigerant liquid leakage.	Press the ICE button twice, restart ice making program, if this problem show up again, verify by a qualified technician.
	Cover motor is broken Pipe in the cooling system is blocked.	
Making Ice too slowly	Hot Air outlet has been blocked by something.	Hot Air outlet must be guaranteed to have more than 15 CM of ventilation distance.
	Water temperature in inner tank is too high.	Water temperature requirement between 7°C-32°C.
	Refrigeration system malfunctions.	Verify by a qualified technician.
Water leakage	Drain plug not in place	Put the drain plug in place.
	Pipe Joint in the appliance may Loose	Verify by a qualified technician.
	The seal has reached service life	Verify by a qualified technician.

TECHNICAL PARAMETERS & CIRCUIT

TECHNICAL PARAMETERS

Model	DGIM44NGBLK	DGIM44NGSTS
Protection Type	I	I
Power	115V/60Hz	115V/60Hz
Ice Making Current	2.5A	2.5A
Refrigerant	R600a / 23g	R600a / 23g
Vesicant	C ₅ H ₁₀	C ₅ H ₁₀
Net Weight	13.5Kg	13.5Kg
Dimension	240x335x390mm	240x335x390mm



CIRCUIT DIAGRAM

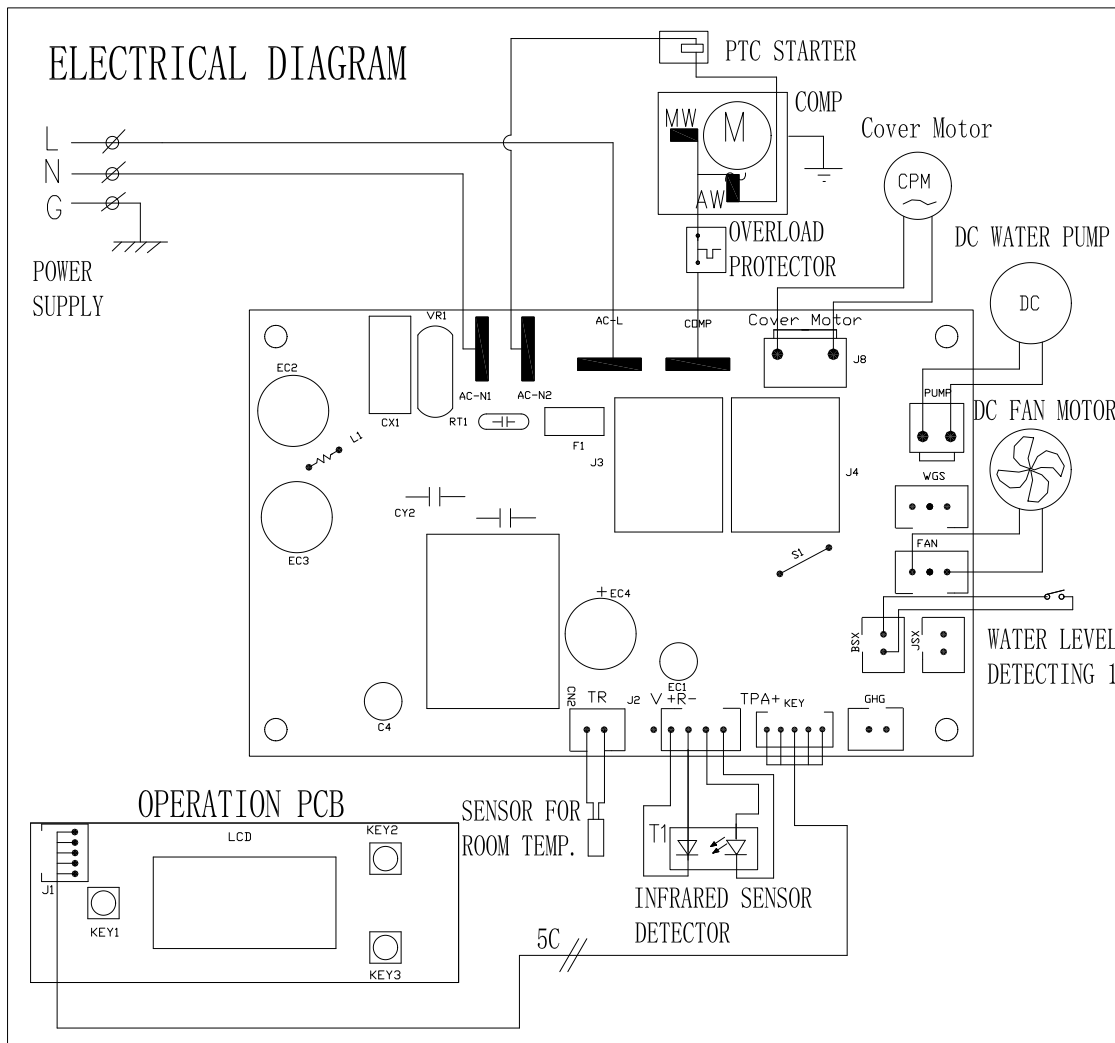

Disposal and Warranty Information

Disposal

When the unit is not to be used again, disposal of this unit's material shall be in accordance with national regulations.

Warranty Information

The manufacturer provides warranty in accordance with the legislation of the customer's own country of residence, with a minimum of 1 year, starting from the date on which the appliance is sold to the end user.

The warranty only covers defects in material or workmanship.

The repairs under warranty may only be carried out by an authorized service technician. When making a claim under the warranty, the original bill of purchase (with purchase date) must be submitted.

The warranty will not apply in cases of:

- Normal wear and tear
- Incorrect use, e.g. overloading of the appliance, use of non-approved accessories
- Use of force, damage caused by external influences
- Damage caused by non-observance of the user manual, e.g. connection to an unsuitable mains supply or non-compliance with the installation instructions
- Partially or completely dismantled appliances



Manufacturer's 1-Year Limited Warranty

The manufacturer warrants that all parts and components are defect free in materials and workmanship for 1 year. This warranty is valid only in accordance with the conditions set forth below:

1. The warranty extends only to the original consumer purchaser and is not transferable. In addition, proof of purchase must be demonstrated.
2. This limited warranty is the only written or express warranty given by the manufacturer. Any implied warranty of merchantability or fitness for a particular purpose on this product is limited in duration to the duration of this warranty. Some states do not allow limitations on how long an implied warranty lasts, so the above limitation may not apply to you.
3. This warranty gives you specific legal rights. You may also have other rights which vary by state

Procedure for Replacement or Return within the 1 Year:

To return the product for replacement or refund within the 1 year, the original purchaser must pack the product securely and send it postage paid with a description of the reason for replacement or refund, proof of purchase, and include your order number on the package, to the following address:

Deco Chef
80 Carter Drive
Edison, NJ 08817

Other contact info

Phone: 844-413-2646

Customer Service Email: customerservice@decogear.com